

Article number: 20132B25B25402SW
Description: E+G 2-way pipe clamp
GN 132-B25-B25-40-2-SW

Measures

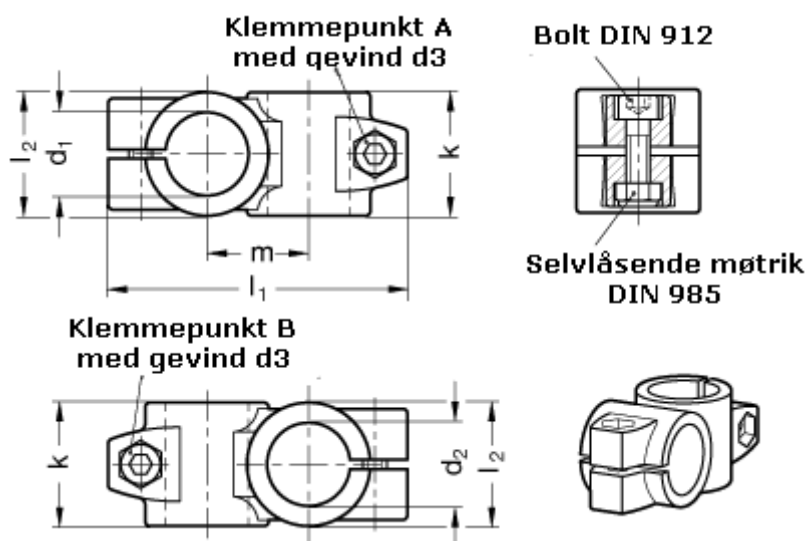

Adjustable clamp lever = GN 911-M 8-32 have to be ordred separately

d1	= 25
d2	= 25
d3	= M 8
k	= 40
l1	= 97.0
l2	= 40
m	= 33